



- 2 & ' \$ \$ % :

5HY \$

^ Z/Wd/KEW

7KH SURGXFWV D B S W D W R X S O L H U H U L Q  
:623 SDFNDJH 7KHQQVH V W F H R F R D Q L Q I U  
R S W L F D O O \ F R X S O W B G W R L D I Q J D Q L W H J L L  
S K R W R G H W H F W R U G H & V F J K L D S U D , W S L H R G Y I S I  
D Q G V S H F L I L F D W L R Q V D W W , M P S V L S D K W W  
V P D O O H U D Q G F R P L S O L W Q R V Q Z I O W K D I L Q W V  
U H L Q I R U F H G L Q V X O D W H R O V W D W O X H U S  
I R U D S S O L F D W L R Q V W K D W U H T X L U H V  
L Q W H U Q D O Q R L G H H V V D L J X O G D S Q V R M H G F R  
W U D Q V L H Q W L P P X Q L W \ L R I L " G H D O M R U V  
D Q G S R Z H U 0 2 6 ) ( 7 J D W H G U L Y H 7 K H S  
L Q L Q G X V W U L D O L R Y G U L W H U V 0 \* 2 6 7 ( 7 D  
L Q G X F W L R Q F R R N W R S D Q G K R P H D S S O

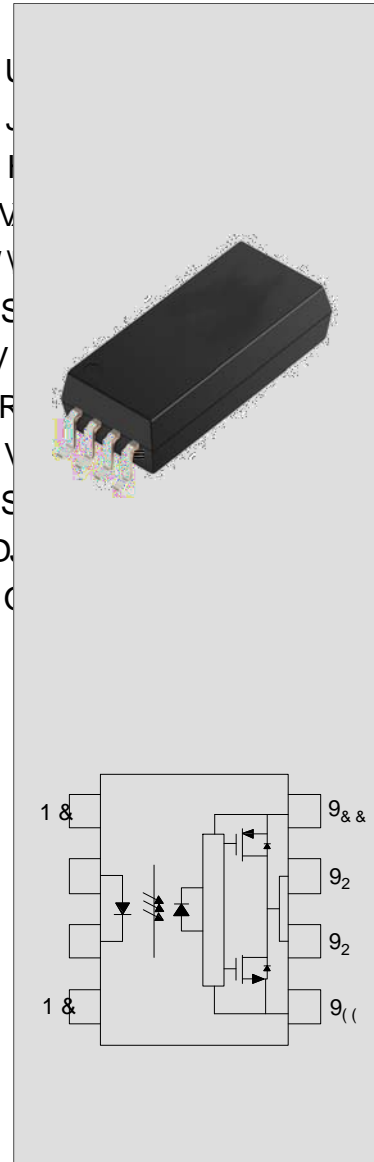

RU  
OXWLR  
UG FHU  
\* % 7  
ZLGHO

D /E & dhZ ^

\$ PD[LPXP SHDN RXWSXW FXUUHQW  
+LJK LVRODWLRQ 9506  
%XIIHU ORJLF W\SH  
2SHUDWLQJ W H U P S O L D W X J U W R f &  
5(\$&+ 5R+6 FRPSOLDQFH  
+%0 + \$ 00 0 &'0 &  
&4& DSSURYHG  
9'( DSSURYHG  
8/ DSSURYHG

dOE μšZ d o

/( ' 2)) 21 21 21	9&& 9( 3RVLWLYH * 9 9	9&& 9( 9 9	*RLQJHJDWLYH *RLQJ 2XWSXW /RZ /RZ 75\$16,7,21 +, * +
2))	9	9	/RZ
21	9	9	/RZ
21	9 9	9 9	75\$16,7,21
21	9 9	9 9	+, * +



^K>hd D y/DhD Z 7HPSHUDWXUH f&

3DUDPHWHU		6\PERO	9DOXH	8QL
/('	)RUZDUG &XUUHQW	)		
	3HDN )RUZDUG &XUUHQW	3	7	\$
	5HYHUVH 9ROWDJH	95		
	3RZHU 'LVVLSDWLRQ	3		P:
'HWHFWRU	2XWSXW 9ROWDJH	2	9	
	6XSSO\ 9ROWDJH	9&		
	3RZHU 'LVVLSDWLRQ	3&		P:
,VRODWLRQ 9ROWDJH		9LVR	8	9UPV
2SHUDWLQJ 7HPSHUDWXUH		7RSU	a	
-XQFWLRQ 7HPSHUDWXUH		7M		
6WRUDJH 7HPSHUDWXUH		7VWJ	a	
7RWDO 3RZHU 'LVVLSDWLRQ		3WRW		P:
6ROGHULQJ 7HPSHUDWXUH		7VRO		

EKd ïï • %µο • U ïï, ì (œ ‹µ v Ç  
EKd î (}œ íu]vµš U ZX,XAđì•òì9

> dZ/ > , Z d Z 7HPSHUDWXUH f&

3DUDPHWHU	6\PERO	&RQGLWLRQ	0LQ	7\S	0I
)RUZDUG 9ROWDJH )	) 9P\$	,			9

,QSXW 5HYHUVH &XUUHQW p# &3H1Är\$1#7P)P)P)P)P) P u €P`WD3H0•



- 2 & ' \$ \$ %





Z Œ š Œ]•š] • μŒÀ •

),\* )RUZDUG &XUUHQW YV )RUZDUG\* 900WDSORZDEOH /(')RUZDUG YV \$PELHQW 7HPSHUDWXUH

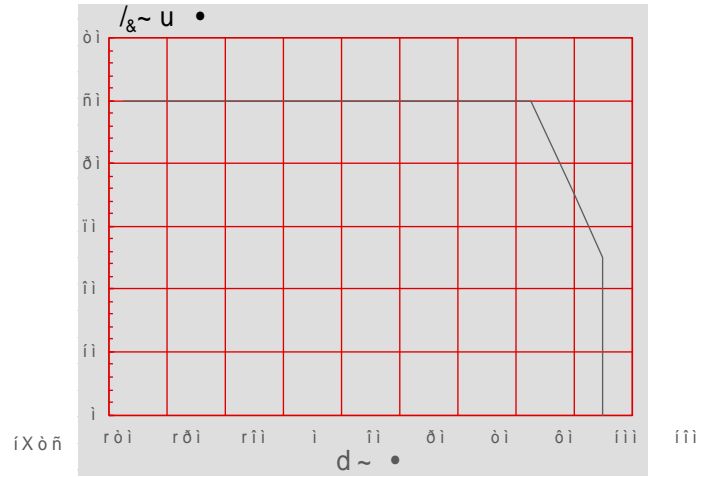
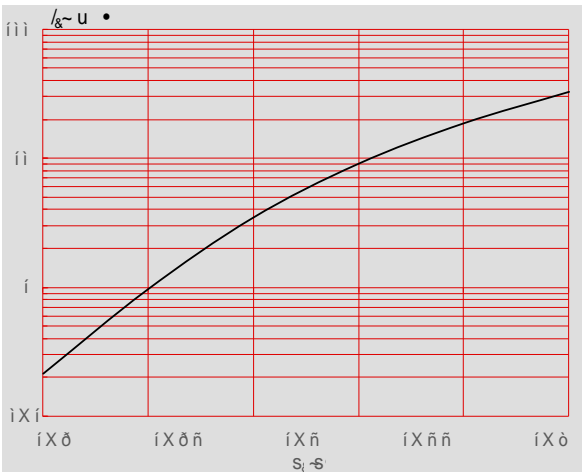

),\* &ROOHFWRU 3RZHU 'LVVLSWLRQ\*YV \$PELHQW ,QSXW &XUUHQW 7HPSHUDWXUH

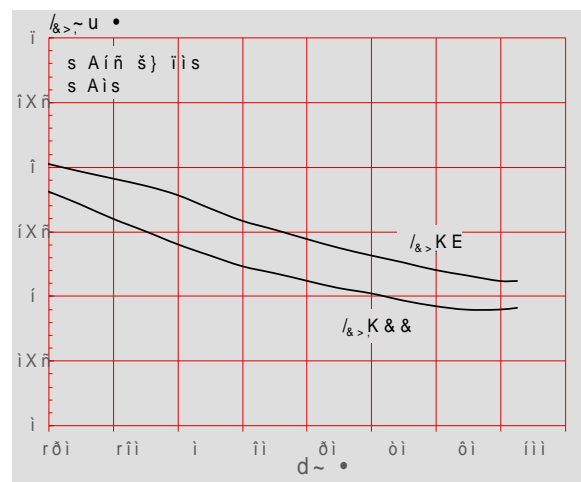

),\* /RZ OHYHO 6XSSO\ &XUUHQW YV \$PELHQW \$PELHQW 7HPSHUDWXUH

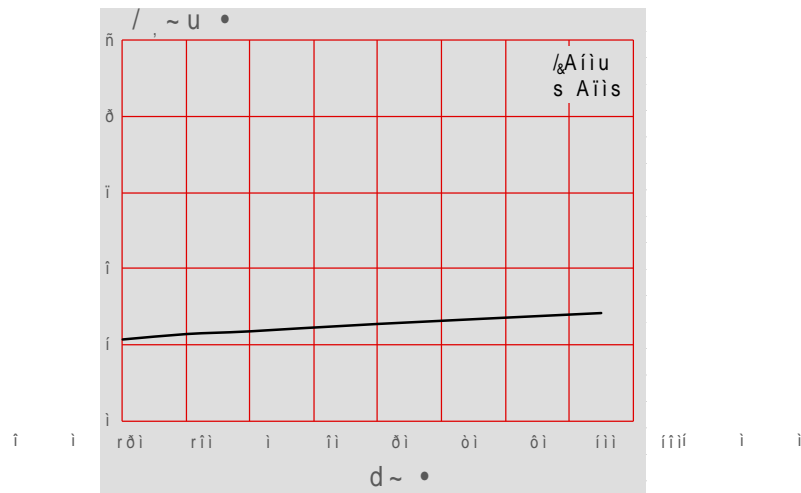
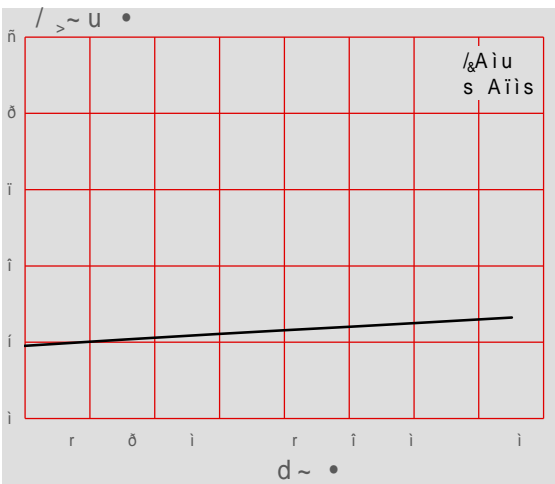

- 2 & ' \$ \$ %



- LH-LH 0LFURHOHFWURQL

), \* /RZ OHYHO 2WVSHXWV9R\$CP ELHQW, \* +LJK OHYHOR 2WVSHXWV9 \$PELH  
7HPSHUDWXUH 7HPSHUDWXUH

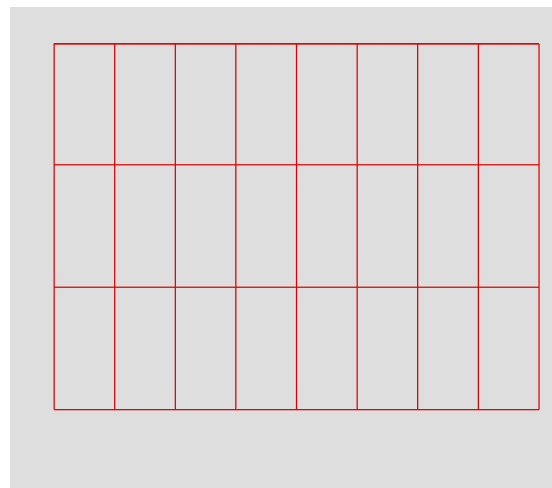
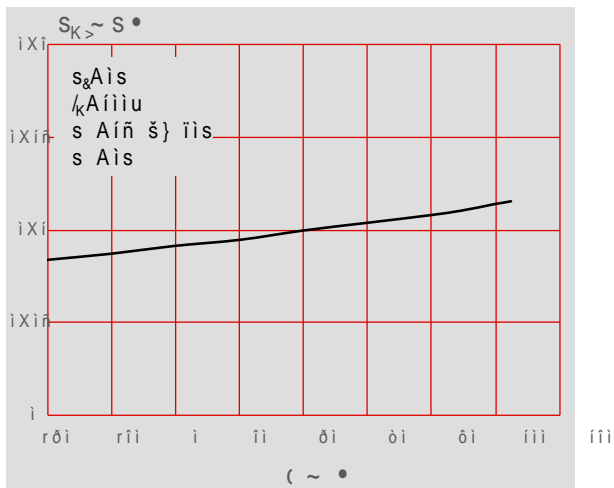

- 2 & ' \$ \$ %



W I P ] u v • ] } v ~ h v ] š W u u •

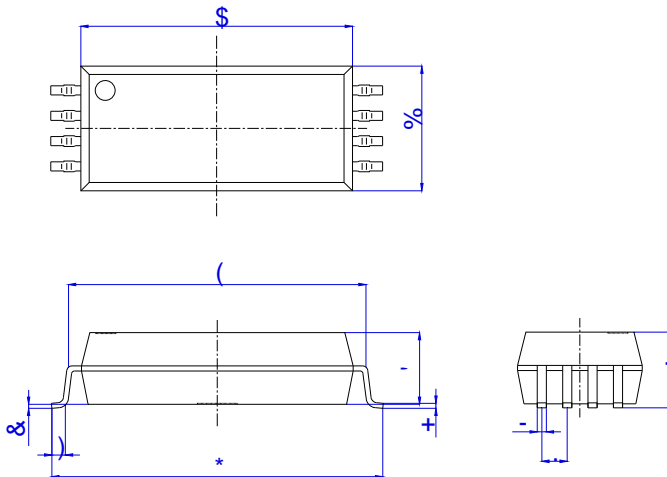

5 HI	'LPHQVLRQV					
	0LOOLPHWHUV			,QFKHV		
	0LQ	7\ S	0D[	0LQ	7\ S	0D[
\$						
%						
&						
'						
(						
)						
*						
+						
,						
-						
.						

- 2 & ' \$ \$ %

 - LH-LH 0LFURHOHFWURQL

ZZ/ Z d W ^W /&/ d/ħ)E^ }v]uu μνo •••ššž ĆÁ]•

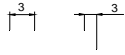







Z & > Kt / E & KZD d / KE

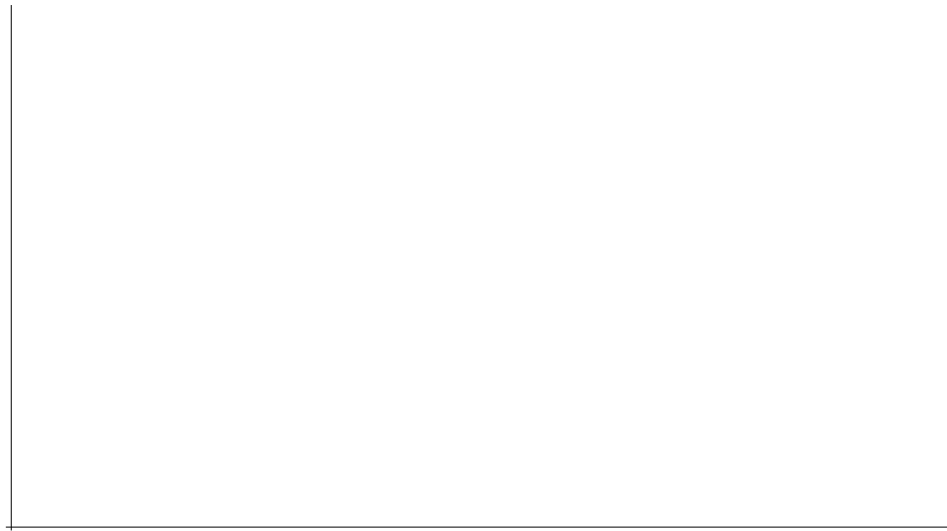
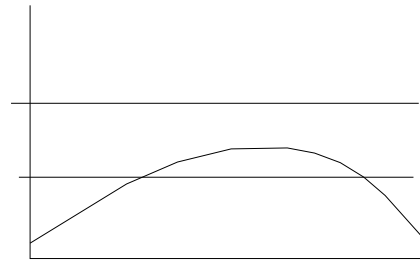
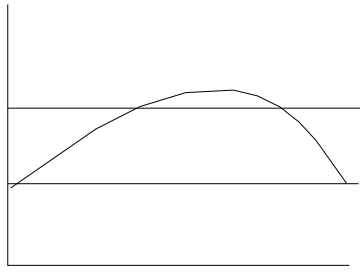



1RWH

5HIORZ VROGHULQJ LV UHFRPPHQGHG/ DWKRVZQH QVHPSHWDWWDQW DQW DQW  
\$YRLG GLUHFW FRQVWDHFWRPHQVZDQWWRUDFRU H[FHHGLQJ LWV PD  
VWRUDJH WHPSHUDWXUH

\$SSOLFDWLRQ RKHUSRYXENRQLWLSOHGDDWHG WHPSHUDWXUHV ,QV  
VFHQDULRV DQHPSVOLGRWRHFFHHG 1

(QVXUH WKH FRPSRQHQW KDV FRROHG WRFRPHQVZDQWWRUDFRU  
PDQXIDFWXULQJ VWHSV

7KH FRPSRQHQWWRUDFRUWRHOI OLI