

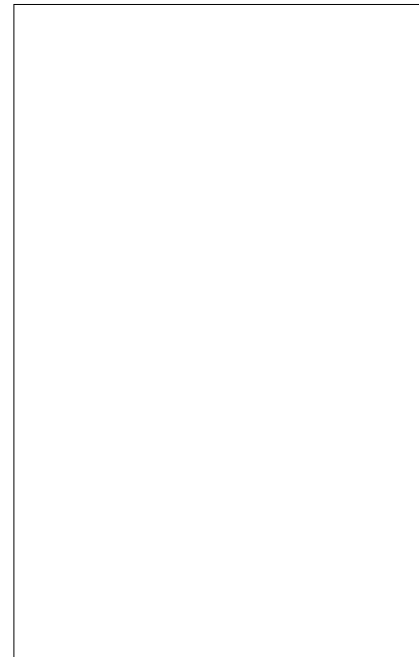

JHX015V 1.5A SCR

Rev.A.1.1

With high ability to withstand the shock loading of large current, JHX015V SCR provides high dV/dt rate with strong resistance to electromagnetic interference. It is especially recommended for use on solid state relay, motorcycle, power charger, T-tools etc. Package SOT-223 is RoHS compliant.



Symbol	Value	Unit
$I_{T(RMS)}$	1.5	A
V_{DRM}/V_{RRM}	1600	V
I_{GT}	3	mA

Parameter	Symbol	Value	Unit
Storage junction temperature range	T_{stg}	-40-150	

Peak gate power	P_{GM}	2	W
Peak pulse voltage ($T_j=25$; non-repetitive,off-state;FIG.8)	V_{pp}	1.5	kV

($T_j=25$ unless otherwise specified)

Symbol	Test Condition	Value			Unit
		MIN.	TYP.	MAX.	
I_{GT}	$V_D=12V R_L=33$	-	-	3	mA
V_{GT}		-	-	1.3	V
V_{GD}	$V_D=V_{DRM} T_j=110 R_L=3.3k$	0.2	-	-	V
I_L	$I_G=1.2I_{GT}$	-	-	15	mA
I_H	$I_T=500mA$	-	-	10	mA
dV/dt	$V_D=1070V T_j=110 R_{GK}=1k$	100	-	-	V/ μs
	$V_D=1070V T_j=110 R_{GK}=220$	500	-	-	
t_{on}	$I_G=10mA I_A=40mA I_R=4mA$	-	2	-	μs
t_{off}	$T_j=25$	-	50	-	μs

Symbol	Parameter		Value(MAX.)	Unit
V_{TM}	$I_{TM}=3A t_p=380\mu s$	$T_j=25$	1.7	V
V_{TO}	Threshold voltage	$T_j=110$	0.91	V
R_D	Dynamic resistance	$T_j=110$	167	m
I_{DRM}	$V_D=V_{DRM} V_R=V_{RRM}$	$T_j=25$	5	μA
I_{RRM}		$T_j=110$	0.2	mA

Symbol	Parameter	Value	Unit
$R_{th(j-c)}$	junction to case(DC)	25	/W
$R_{th(j-a)}$	junction to ambient (DC)	65	/W

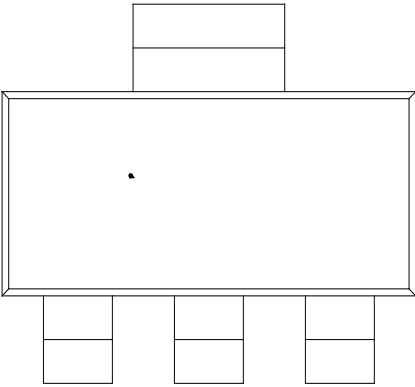
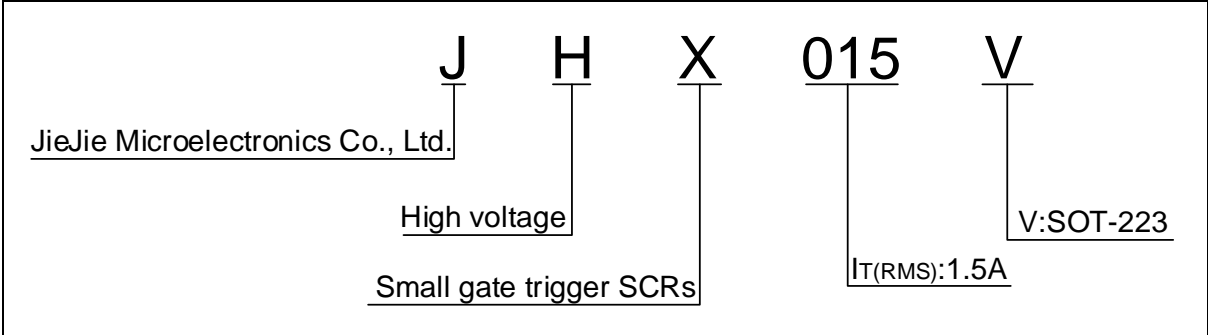

FIG.1: Maximum power dissipation versus RMS on-state current

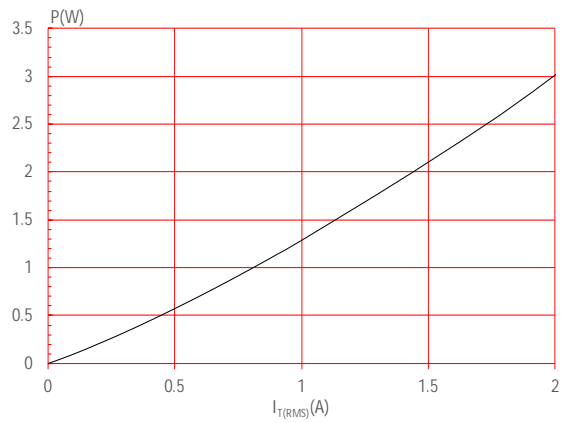

FIG.2: RMS on-state current versus case temperature

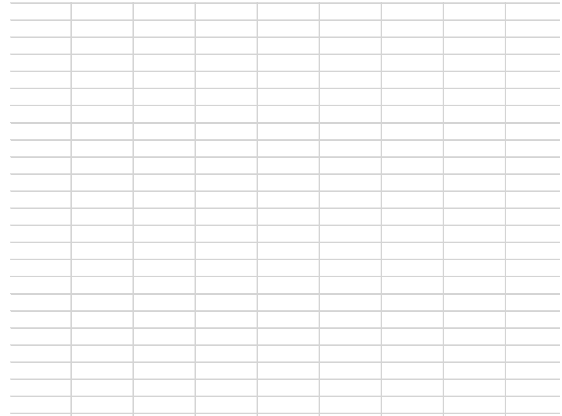
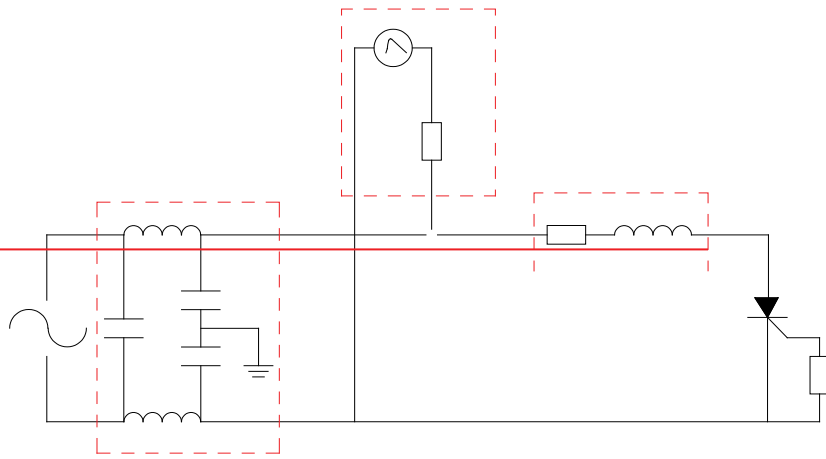

FIG.7: Relative variations of gate trigger current, holding current and latching current versus junction temperature



FIG.8 Test circuit for inductive and resistive loads to IEC-61000-4-5 standards.



Order code	Voltage V_{DRM}/V_{RRM} (V)	IGT(mA)	Package	
------------	----------------------------------	---------	---------	--

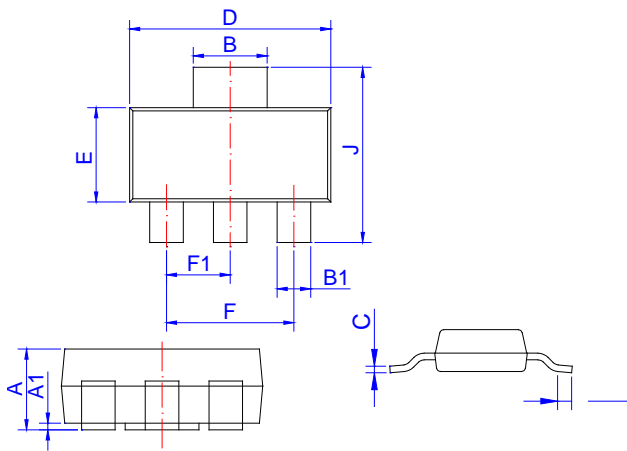

Ref.	Dimensions					
	Millimeters			Inches		
	Min.	Typ.	Max.	Min.	Typ.	Max.
A	1.50	1.60	1.80	0.059	0.063	0.071
A1	0.01	0.06	0.10	0.001	0.002	0.004
B	2.90	3.00	3.10	0.114	0.118	0.122
B1	0.60	0.70	0.80	0.024	0.028	0.031
C	0.22	0.26	0.32	0.009	0.010	0.013
D	6.30	6.50	6.70	0.248	0.256	0.264
E	3.30	3.50	3.70	0.130	0.138	0.146
F	4.40		4.80	0.173		0.189
F1	2.20		2.40	0.087		0.094
G	0.50		1.00	0.020		0.039
H	1.50	1.75	2.00	0.059	0.069	0.079
J	6.70	7.00	7.30	0.264	0.276	0.287
K	0.80		1.00	0.031		0.039

Ref.	Dimensions					
	Millimeters			Inches		
	Min.	Typ.	Max.	Min.	Typ.	Max.

Information furnished in this document is believed to be accurate and reliable.
However, Jiangsu JieJie Microelectronics Co., Ltd. assumes no responsibility for the