

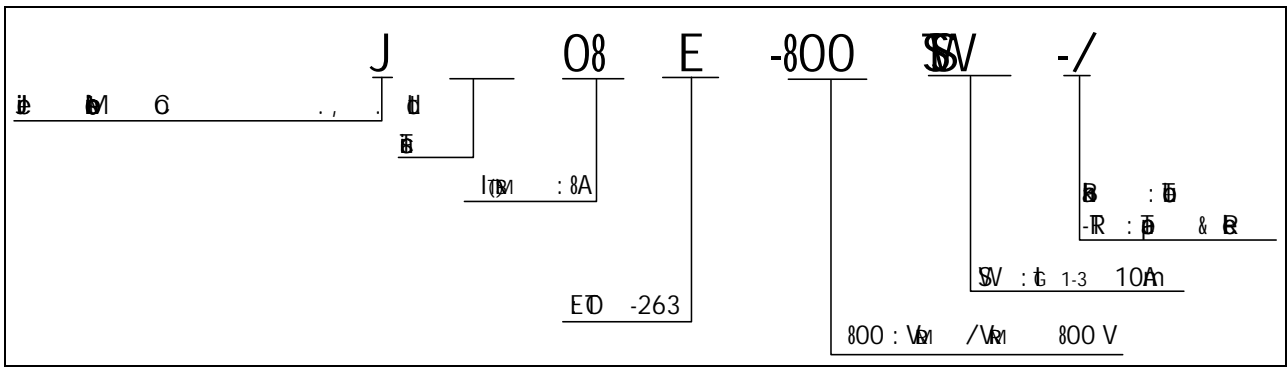



ORDERING INFORMATION



MARKING

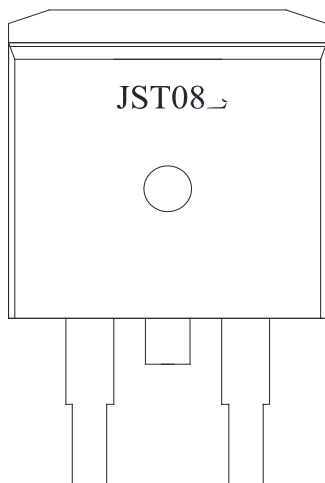
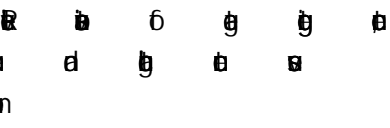
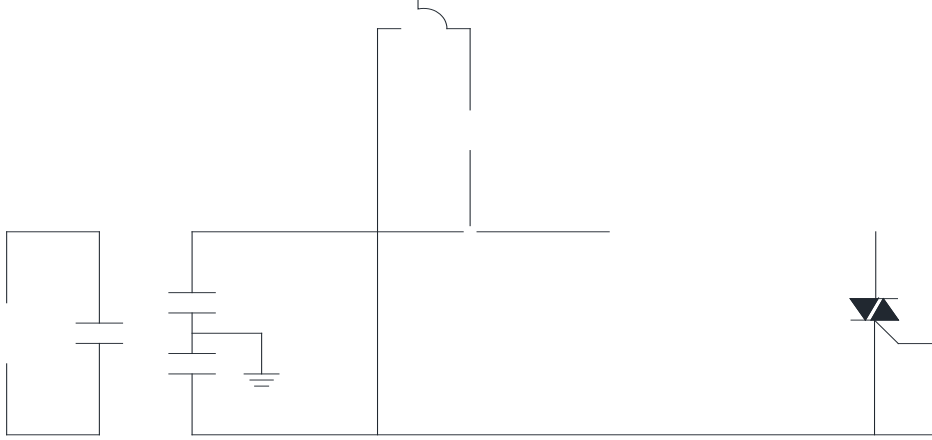

FIG.1:

FIG.7: 



## ORDERING INFORMATION

Order code	Voltage $V_{DRM}/V_{RRM}$ (V)	IGT(mA)	Package	Base qty. (pcs)	Delivery mode
		- -			
JST08E-800SW	800	10	TO-263	50	Tube
JST08E-800SW-TR				800	Tape & Reel

**Document Revision History**

PACKAGE MECHANICAL DATA

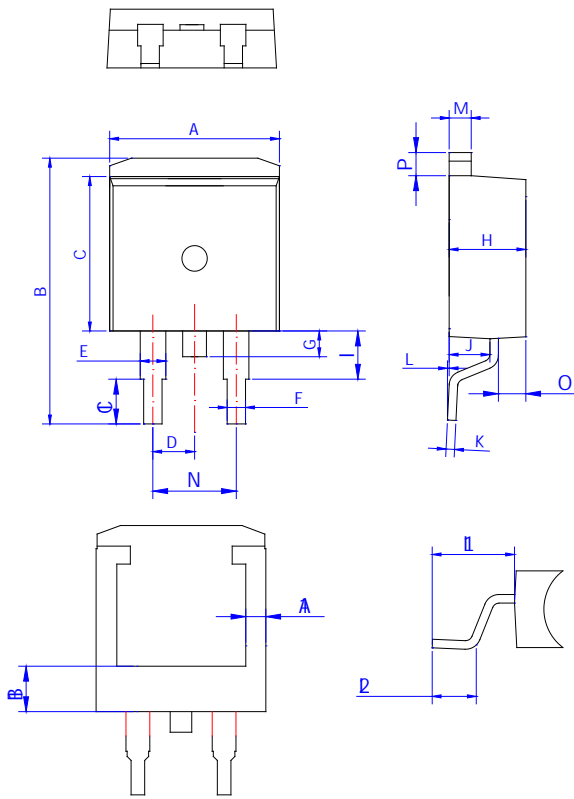

R	B					
	M			B		
	M	μ	M	M	μ	M
A	9.90		10.20	0.390		0.402
A	0.80		1.20	0.031		0.047
B	14.70		15.80	0.579		0.622
B	2.15		2.55	0.085		0.100
C	9.40		9.60	0.370		0.378
C	2.40		2.80	0.094		0.110
D	2.40		2.70	0.094		0.106
E	1.20		1.50	0.047		0.059
F	0.75		0.85	0.029		0.033
G	1.00		1.50	0.039		0.059
H	4.40		4.70	0.173		0.185
I	1.80		2.20			
J	2.30		2.70	0.091		0.106
K	0.38		0.55	0.015		0.022
L	0	0.10	0.25	0	0.004	0.010
L	4.65		5.05	0.183		0.199
P	1.90			0.075		
M	1.25		1.35	0.049		0.053
N	4.80		5.20			
O	1.30		1.50			
P	1.20		1.50	0.047		0.059

FOOTPRINT-TO-263(dimensions in mm)

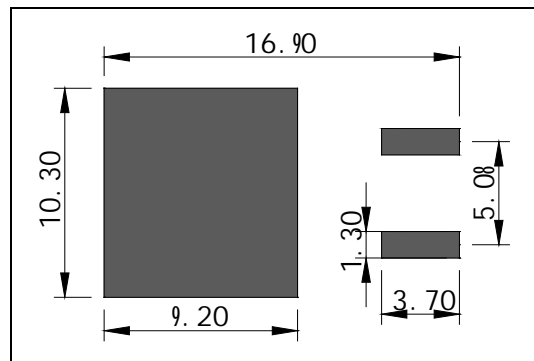

DELIVERY MODE

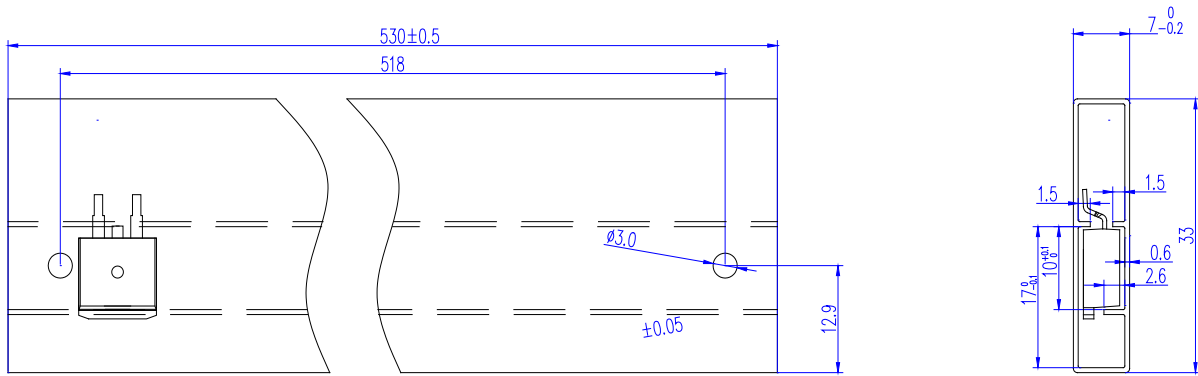

PACKAGE

此文件是本公司之机密文件，其内容包含本公司之商业秘密。未经本公司书面许可，任何人不得复制或传播此文件。如有违反，本公司将依法追究法律责任。

本公司保留对本文件内容之修改权。如有任何疑问，请洽本公司技术支持部门。

版权所有 © 2025 捷捷微电子有限公司